

Sewer Backup Protection Grant Program

Guidelines, materials and frequently asked questions

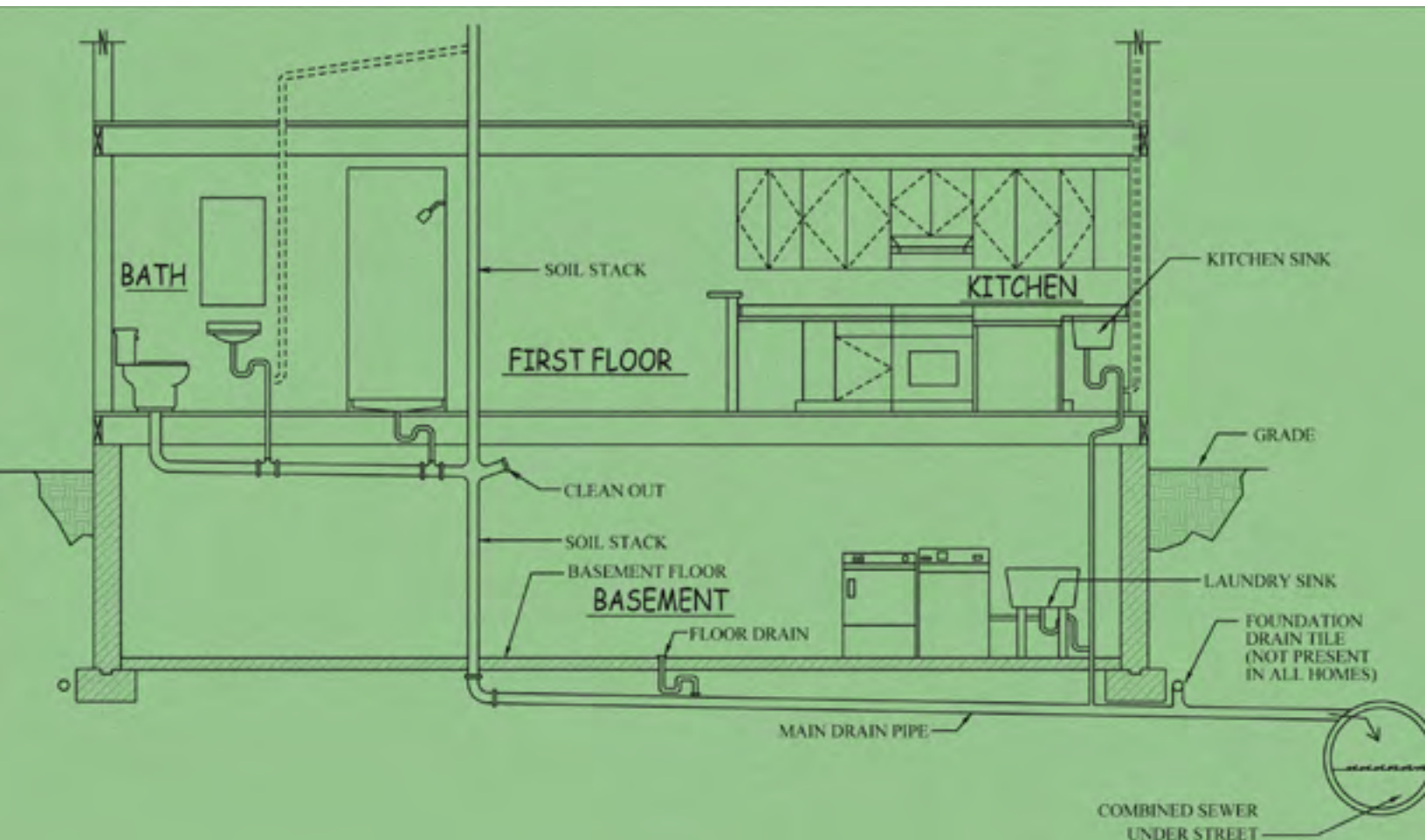

SEWER BACKUP PROTECTION GRANT

PROGRAM GUIDELINES

I. WHAT IS IT?

The Village of Oak Park Sewer Backup Protection Grant Program was established to provide financial assistance to homeowners who desire to protect their home from sewer backup during a heavy rain event. The program's intent is to offset a portion of the expense that a homeowner will incur to modify the building's plumbing system such that sewage cannot backflow in to the building when the Village sewers are full. Eligible homeowners may qualify for a Grant of 50% of the total cost of sewer backup prevention improvements, up to a maximum of \$3,500.00, to install either an Overhead Sewer System or a Backflow Prevention Valve System.

II. HOW DO THESE SYSTEMS WORK?

The typical layout of an existing home plumbing system is shown on Figure 1. This program will fund modifications to residential plumbing systems to provide sewer backup protection. There are three basic options:

1. Modify the sewer piping and inside plumbing that goes out to the Village sewer in a new Overhead Sewer System and eliminate all gravity drainage below the basement floor (See Figure 2).
2. Modify the inside plumbing by disconnecting all basement level plumbing fixtures from the gravity drainage system and redirect their discharge to an ejector pump. The pump then discharges into an existing soil stack. This is referred to as a Modified Overhead Sewer System (See Figure 3).
3. Install a Backflow Prevention Valve System and bypass the sewer line in an underground manhole (See Figure 4).

NOTE: Although the Clean Check® valve does work, this system is not approved under the grant program.

Each of the above approaches has different costs, degrees of disruption and levels of protection.

Please note that the Village strongly recommends installation of a new Overhead Sewer System because it provides the greatest protection under all weather conditions and storm events to prevent sewage from entering the building.

This Program is designed to assist homeowners in reducing the risk of basement flooding due to sewer backups. However, there is always a risk of a sewer backup as a result of unexpected sewer collapse, obstruction, power failure, extreme environmental or weather conditions or other unforeseen factors, as well as basement flooding due to seepage and other causes. Homeowners assume the risk of loss of any future property damage due to flooding.

Homeowners are required to disconnect roof drainage/downspouts from directly draining into the sewers as part of this program, unless the Director of the Building and Property Standards Department grants an exemption.

III. WHAT ELSE SHOULD I DO TO PROTECT MY BASEMENT?

In order to fully protect a basement from flooding, in addition to installing overhead sewers, homeowners should make sure foundation drains are operating properly to prevent seepage of ground water through walls below grade. (This Program does not cover existing foundation drains, and the Village will not test them for proper operation under this Program.) The homeowner has the responsibility for all testing, inspections and any corrective work that may become necessary.

Homeowners should also make sure their sump/ejector pump(s) operates reliably. The continuous operation of sump/ejector pumps is necessary for the proper functioning of overhead sewers, backflow prevention valves and foundation drains. The homeowner is responsible to check the operation of the pumps regularly. The homeowner is responsible for all testing, inspections and any corrective work that may become necessary after the improvements covered by this Program are installed.

Homeowners should also install a battery backup system to provide protection in the event of power failure.

IV. WHAT WORK IS COVERED UNDER THIS GRANT PROGRAM?

This Program covers Sewer Backup Protection measures. The following are **Eligible** costs which may be covered as part of this program:

- Cost of location, excavation and exposure of the building sewer, including the support of existing structures, for reconnection to a new overhead sewer to the existing sewer line.
- Cost of a new pump pit, ejector pump and associated electrical and plumbing works needed to lift the drainage from basement plumbing fixtures to an overhead sewer or existing soil stack.
- Cost of trenching and concrete floor replacement.
- Cost of installing a backflow prevention valve with a bypass (new sump and ejector pump in an underground vault) and associated electrical and plumbing work.
- Cost of grass seeding or sod to restore disrupted landscape.
- Battery backup system.
- Applicable permit fees.

The following are **Non-Eligible** costs which will not be covered by this program:

- Removal and replacement of interior basement walls and finishes.
- Use of materials not meeting the requirements of the Village's Specifications or Codes.

- Ancillary homeowner improvements not necessary to provide sewer backup protection of the basement.
- Planting of new or replacement landscaping (bushes and trees) other than grass seeding or sod.
- New electrical panels and/or upgrading the house electrical supply.
- Costs associated with disconnecting downspouts and roof drains from the Village's sewer system.

V. WHO IS ELIGIBLE TO PARTICIPATE IN THIS PROGRAM?

This program is open to owner occupied single-family homes that are susceptible to sewer backup by way of a gravity sewer line. Single family is defined as both traditional single family homes as well as multi-family residences of 1-4 units where the owner occupies at least one unit. Homeowners who previously installed sewer backup protection systems and who otherwise meet the eligibility criteria also may participate in this Program, provided the permit for the work was issued after January 1, 2010. A property will be eligible for this program only once.

Applications will be received until the funds dedicated to this purpose have been expended, or December 31, whichever is sooner.

Homeowners will be considered ineligible if:

- Any unpaid taxes or water bills or other debt is due to the Village.
- Any unpaid final judgments of liability from the office of Adjudication are due and owing.
- Any unpaid Village liens are on any property owned by the applicant.
- Any outstanding Code violations exist that the homeowner has been advised of and had not corrected.
- Homeowner is not current on any other Village obligations, or otherwise not in compliance with requirements of the Village Code, including but not limited to multi-family licensing, alarm permitting or vacant building registration.
- Property previously received a grant under this Program.

Eligibility of Village Employees

Otherwise eligible homeowners who are also Village Employees are eligible for the program in accordance with the Village's Conflict of Interest and Ethics Ordinance.

Eligibility for Other Housing Programs

Participants in the Sewer Backup Protection Grant Program continue to be eligible for other Village Housing Programs provided they meet the eligibility criteria for those programs.

VI. HOW DO I APPLY?

A. Steps

The following are the basic steps to take to participate in the Program:

1. Homeowners must complete an application and submit it to the Housing Programs Division.
2. Homeowners must provide detailed drawings and a proposal from an Illinois licensed plumbing contractor, including all technical information on pumps, valves, electrical work, etc. The Village encourages homeowners to obtain at least three estimates from qualified contractors for this work. All contractors must register with the Village to do work in Oak Park in accordance with existing Building and Property Standards procedures.

B. Priority

Applications will be processed on a first come, first served basis. The program will expire when the Grant Funds are expended, or December 31, whichever is sooner.

VII. PROGRAM MANAGEMENT

A. Application and Eligibility Review

The Housing Programs Division will review the completed application with Village staff for an initial determination of eligibility. If the homeowner meets the eligibility criteria, the Housing Programs Division will forward the application to the Department of Building and Property Standards (BPS) for review. Once the BPS has reviewed the request, the Grant application will be forwarded to the Housing Programs Division for further processing.

B. Ineligibility

If the homeowner is not eligible, the Housing Programs Division will notify the homeowner of the reason for the ineligibility. If the reason for the ineligibility is due to an outstanding debt, judgment or code compliance issue, the homeowner will be allowed to satisfy those obligations, come into compliance with the Village Code and re-apply. For purposes of determining priority, the homeowner's place in line will be based upon the date of reapplication.

C. Agreement

Upon approval of the application, the homeowner will be required to sign a Grant Agreement substantially in conformance with the Agreement provided with this Program Document.

D. Building Permits

The homeowner must obtain permits from the Building and Property Standards Department before the contractor may begin work. All work shall be performed in accordance with the Village's Building and Electrical Codes and the Illinois Plumbing Code. The contractor shall schedule necessary inspections by the Building and Property Standards Department throughout the construction.

E. Disconnect Downspouts

As part of the Program, all participants must disconnect any downspouts from the Village's combined sewer system and must take all corrective action necessary to prevent the discharge of roof drainage into the Village's combined sewer systems, unless an exemption is obtained from the Director of the Building and Property Standards Department.

F. Payment of Requests for Reimbursement

Upon completion of the work, the homeowner must submit a Request for Reimbursement Form. The form must be accompanied by the following:

1. Copy of the homeowner's proof of payment to the contractor
2. Certification from the contractor of the work performed
3. Certification from the Building & Property Standards Department that the work was completed in accordance with all applicable codes and passed final inspection.
4. In those cases where homeowner requests that payment be made directly to the contractor, the homeowner must sign a Payment Authorization form and provide mechanics lien waivers. The Village will agree to pay the contractor directly upon proof that the Village's payment is the only outstanding payment to be made to the contractor.

If the Request for Reimbursement is in conformance with the program requirements, the Request will be forwarded to the Village's Finance Department for payment. Payment will be made within 30 days of approval of the invoice.

Note: Requests for reimbursement for work completed in 2010 or later require the homeowner to show proof of permit, final inspection from the Village and a detailed paid receipt of the work completed.

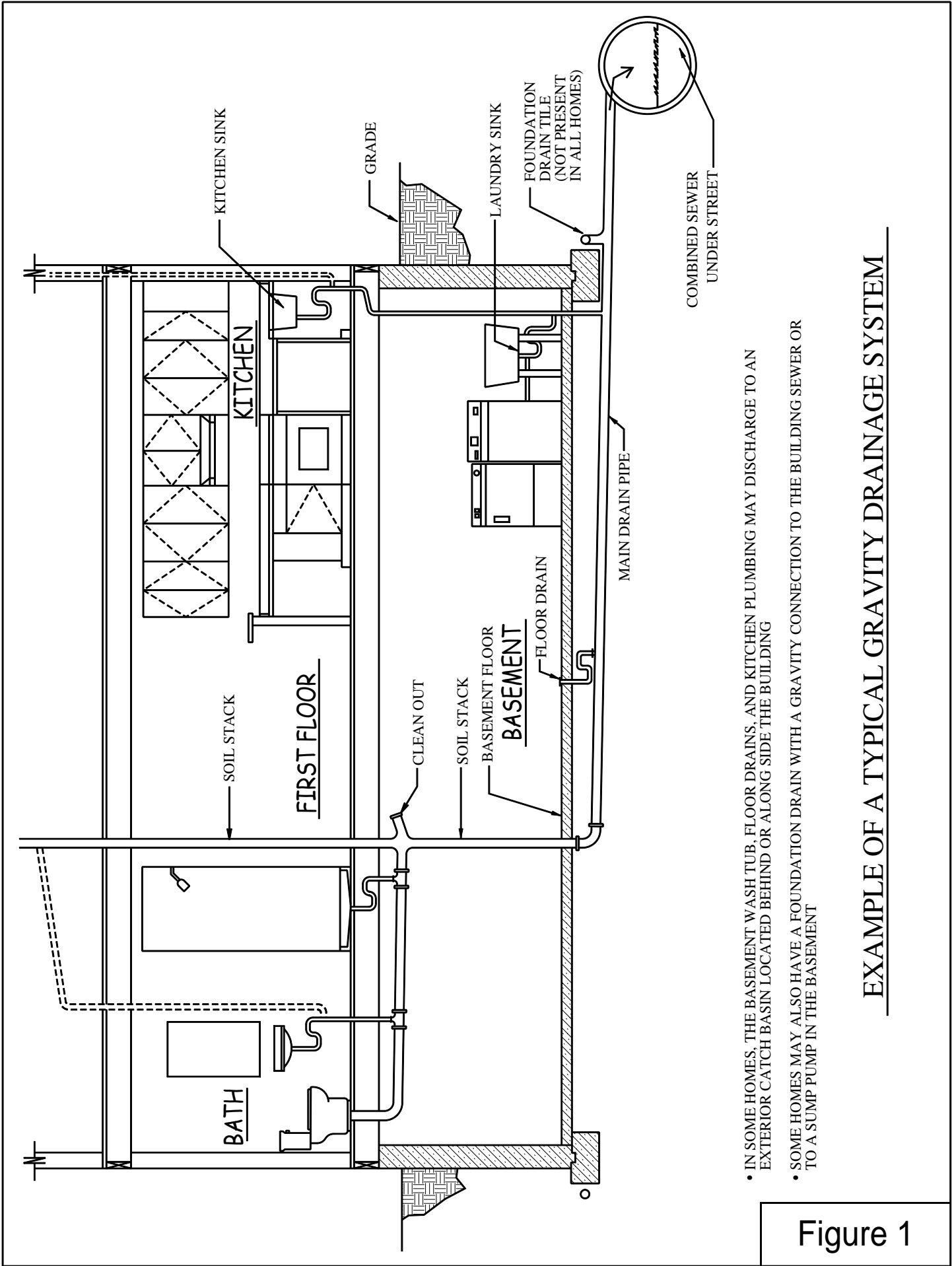

- IN SOME HOMES, THE BASEMENT WASH TUB, FLOOR DRAINS, AND KITCHEN PLUMBING MAY DISCHARGE TO AN EXTERIOR CATCH BASIN LOCATED BEHIND OR ALONG SIDE THE BUILDING
- SOME HOMES MAY ALSO HAVE A FOUNDATION DRAIN WITH A GRAVITY CONNECTION TO THE BUILDING SEWER OR TO A SUMP PUMP IN THE BASEMENT

EXAMPLE OF A TYPICAL GRAVITY DRAINAGE SYSTEM

Figure 1

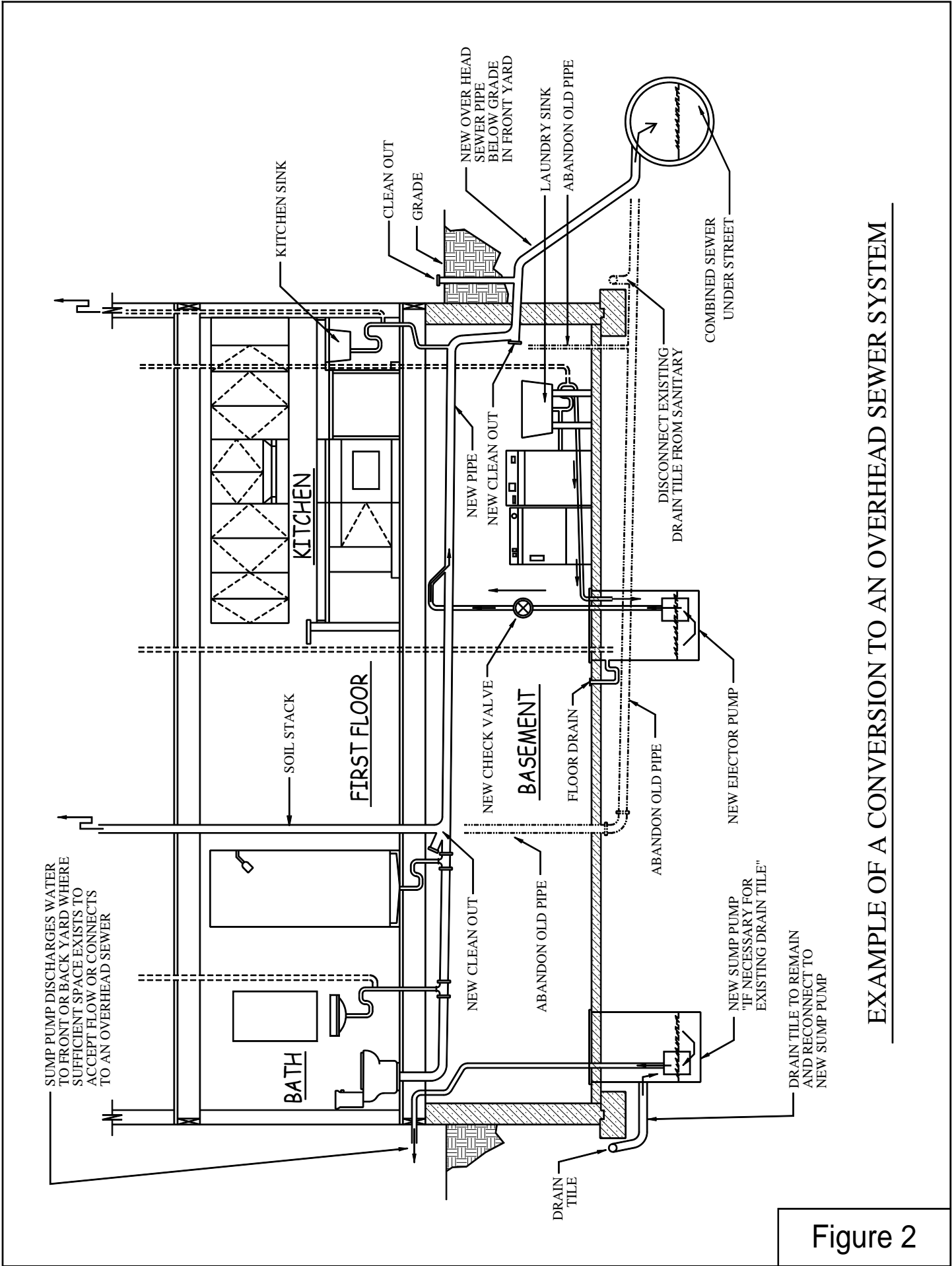

EXAMPLE OF A CONVERSION TO AN OVERHEAD SEWER SYSTEM

Figure 2

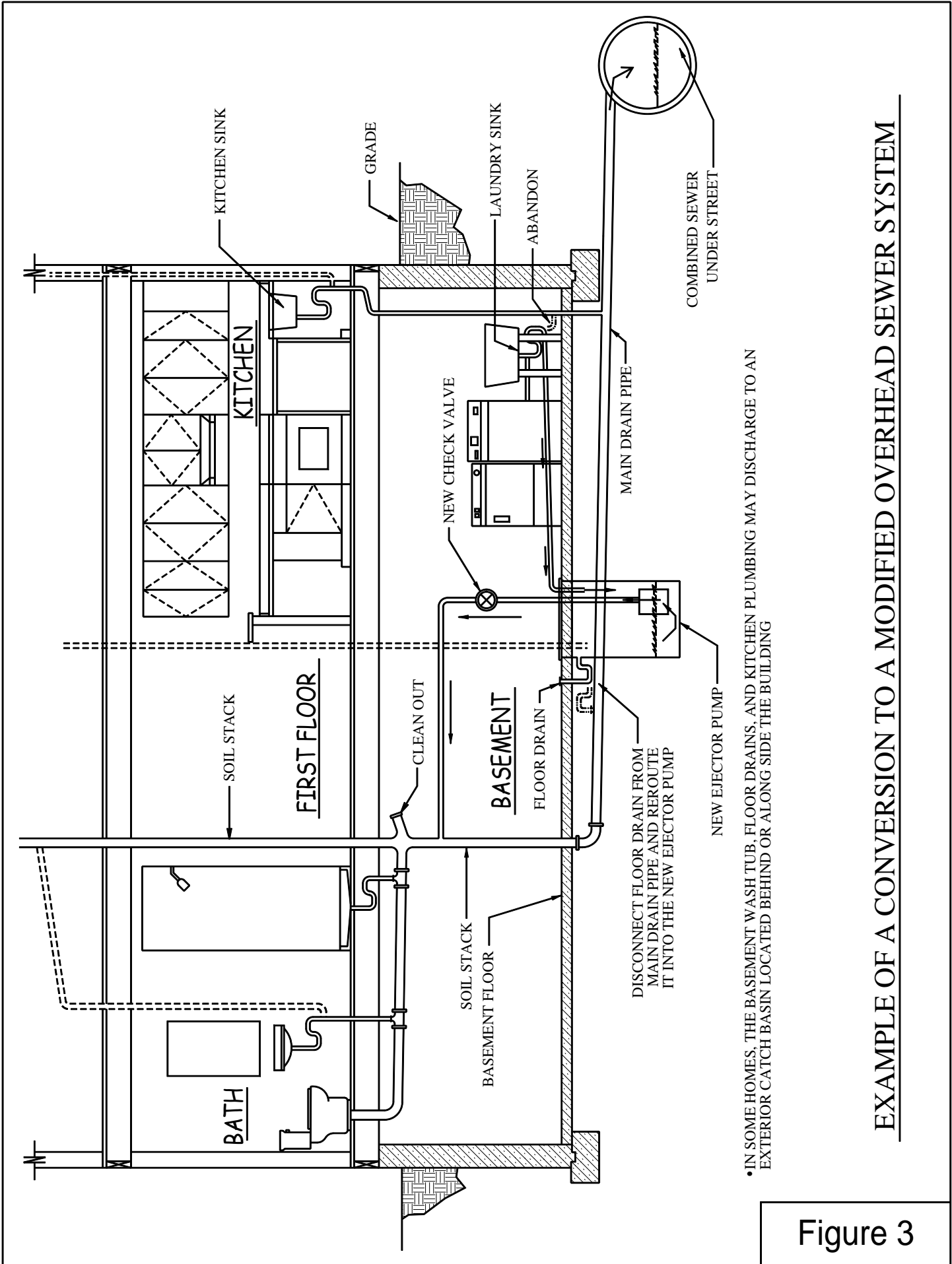

• IN SOME HOMES, THE BASEMENT WASH TUB, FLOOR DRAINS, AND KITCHEN PLUMBING MAY DISCHARGE TO AN EXTERIOR CATCH BASIN LOCATED BEHIND OR ALONG SIDE THE BUILDING

EXAMPLE OF A CONVERSION TO A MODIFIED OVERHEAD SEWER SYSTEM

Figure 3

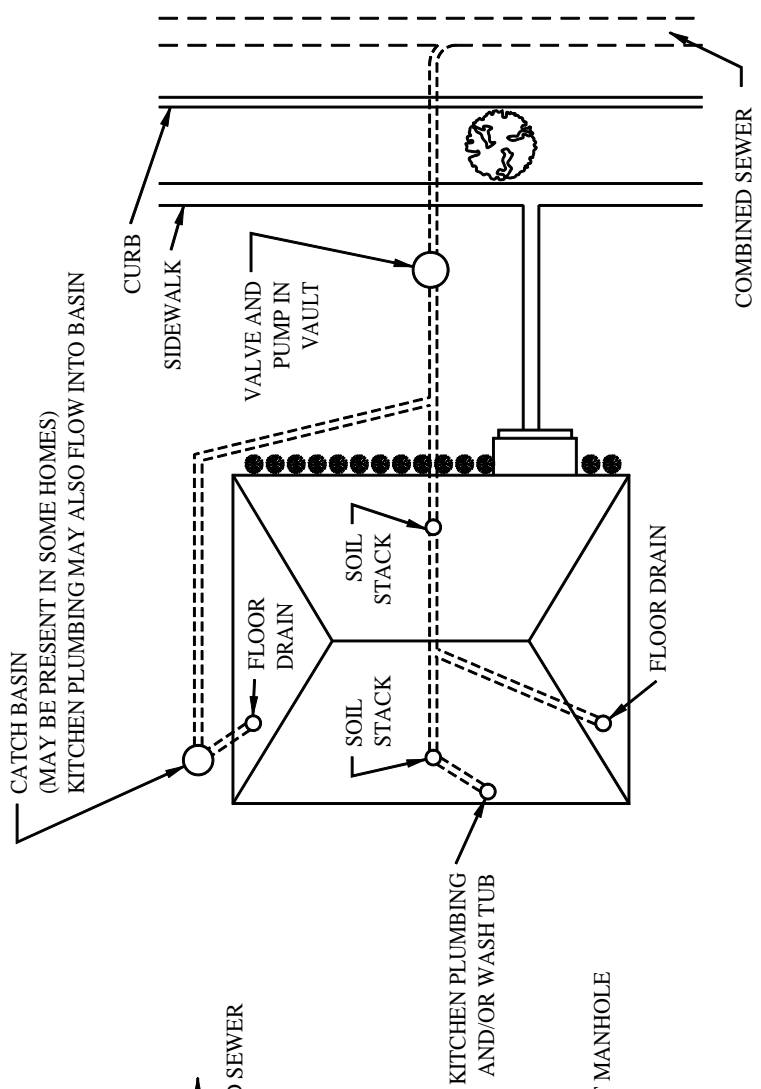

PLAN VIEW

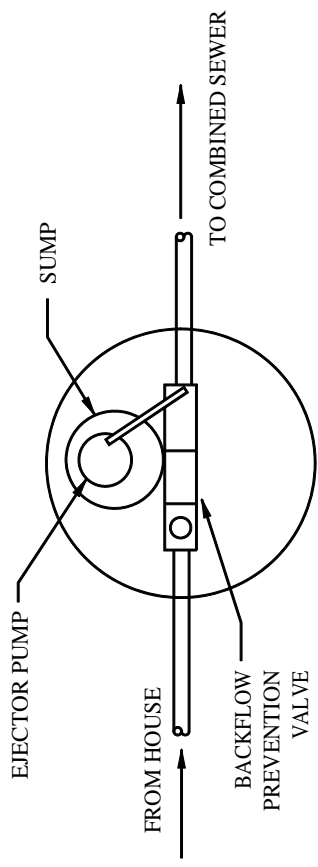

TOP VIEW

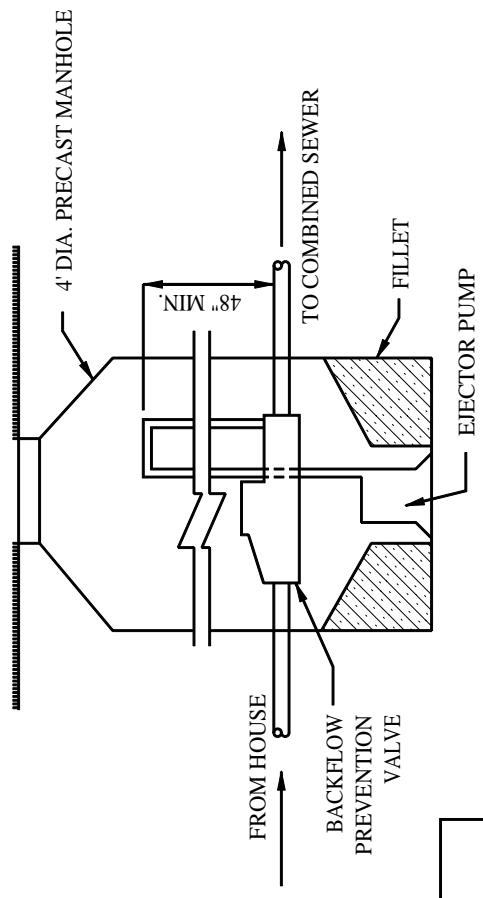

SIDE VIEW

**EXAMPLE OF A TYPICAL INSTALLATION OF
A BACKFLOW PREVENTION VALVE**

Figure 4

The Sewer Backup Protection Grant Program was established to provide financial assistance to homeowners who install systems to protect their homes from sewer backup during a heavy rain event. The program's intent is to offset a portion of the expense of modifying a building's plumbing system to prevent backflow when Village sewers are at capacity. Eligible homeowners may qualify for a grant of 50 percent of the total cost of sewer backup prevention improvements, up to a maximum of \$3,500 for installing either an overhead sewer system or a backflow prevention valve system. For more information, call 708.358.5410 or e-mail housing@oak-park.us.

Q: What work is eligible for the Sewer Backup Prevention Grant Program?

A: Eligible work includes installing an overhead sewer system or a backflow prevention system. Illustrations in the program guidelines show how a typical house is connected to a sewer by a gravity system, and how overhead sewers and backflow prevention systems are installed to alleviate sewer backups.

Q: Who is eligible to apply for the Sewer Backup Prevention Grant Program?

A: This program is open to owner-occupied single-family homes that are susceptible to sewer backup by way of a gravity sewer line. Single-family is defined as both traditional single-family homes as well as multi-family residences of 1-4 units where the owner occupies at least one unit.

Q: I installed an overhead sewer system after the flooding in 2010. Can I apply for a grant for that work?

A: Yes. Any eligible work that received permits after January 1, 2010 is eligible. You will have to provide information regarding the permits and proof of payment.

Q: Will the grant reimburse me for replacing the carpet and walls in my basement after it flooded?

A: No. Only work to prevent future backups into basements are eligible. Restoration of finishes and replacement of property are not eligible.

Q: Does the work need to be completed before I submit my application?

A: No. You do not need to complete the work before submitting an application. However, you do need to have a licensed plumber determine the scope of work before submitting your application. You should submit your application after you have determined what work will be performed.

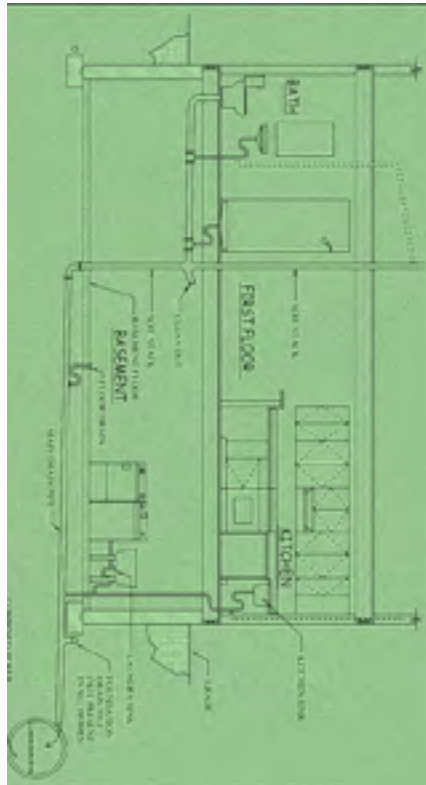

Q: Will a preference be given to applicants that have completed the work?

A: No. Applicants with completed work will not receive preferential treatment.

Q: How do I apply?

A: Directions for applying are detailed in the program guidelines. Complete all application materials and submit them to the Housing Programs Division, along with all required documents.

Q: Can I e-mail or fax my application?

A: Yes. Forms may be mailed, hand-delivered, e-mailed or faxed to the Village of Oak Park, Attention Housing Programs Division, 123 Madison, Oak Park, IL 60302. The e-mail address is housing@oak-park.us and the fax number is 708.358.5114.

Q: In what order will you process applications?

A: Completed applications will be

processed in the order in which they are received.

Q: We completed our project in 2010 but we did not get a building permit? Are we still eligible?

A: Yes, you are eligible to apply. However, your application will not be processed until you have obtained all required permits, paid all applicable fees and fines and passed final inspection.

Q: We had a permit for our project but I don't remember getting a final inspection. What impact will this have?

A: The Village can determine if a final inspection occurred. If a final inspection was not conducted, you will be required to obtain one before receiving a grant.

Q: Will permit fees necessary for the work be waived?

A: No. All applicable permit fees are the responsibility of the property owner.

Q: Do I have to disconnect my downspouts to be eligible?

A: You must either disconnect your downspouts or obtain a waiver for downspouts that are not disconnected. Waivers will be issued only to those properties where disconnecting the downspout would negatively affect a neighboring property or create a hazardous condition. The Village will review requests for waivers and make a final determination.

Q: How will I know that you received my application?

A: Applicants will be notified within two business days that their applications were received. Notification will be made by the same means that the application was submitted.

Q: Who can I contact for more information?

A: Contact the Housing Programs Division via e-mail to housing@oak-park.us or call 708.358.5410.

This page intentionally left blank.



Sewer Backup Protection Grant Program Application

The Village of Oak Park
Housing Programs Division
123 Madison St.
Oak Park, IL 60302

708.358.5410
708.358.5114 fax
housing@oak-park.us
www.oak-park.us

GENERAL INFORMATION

Residential category: Single-family home Owner Occupied
Application for: Work to be done Work already done Date completed: _____

Owner Name _____ Application Date _____

Building Address _____

Daytime Phone Number _____ E-mail Address _____

Names of all Title Holders _____

Date moved into home/building _____

REQUIRED MATERIALS

The following documents must be attached to this application in order for the application to proceed.

- Signed and dated Sewer Backup Protection Grant Program Application
- Copy of detailed proposal and paid invoice from an Illinois licensed plumbing contractor for completed work
- Copy of necessary permits and final inspection for work completed
- Signed and dated Sewer Backup Protection Grant Request for Reimbursement
- Signed and dated Homeowner's Participation Agreement

Submit completed application: Village of Oak Park, Housing Programs Division, 123 Madison St., Oak Park, IL 60302 or housing@oak-park.us

OWNER CERTIFICATION

I, _____, certify that I am the owner and occupant of the property listed above and I certify that all the information contained in this application is true and correct to the best of my knowledge.

Applicant Signature _____ Date _____

OFFICE USE ONLY

Date application received _____ Received by _____



Sewer Backup Protection Grant Request for Reimbursement

The Village of Oak Park
Housing Programs Division
123 Madison St.
Oak Park, IL 60302

708.358.5410
708.358.5114 fax
housing@oak-park.us
www.oak-park.us

GENERAL INFORMATION

Owner Name	Application Date
Building Address	
Daytime Phone Number	E-mail Address

SCOPE OF WORK

Date work was completed	Permit #
Name of contractor performing work	
Total cost of eligible expenses (attach paid receipt)	
Total amount of grant requested (50 percent of eligible expenses, not to exceed \$3,500)	
Scope of work performed:	<input type="checkbox"/> Installed Overhead sewer system
(check all that apply)	<input type="checkbox"/> Installed modified overhead sewer system
	<input type="checkbox"/> Installed backflow prevention valve and sump pump
	<input type="checkbox"/> Disconnected downspouts from Village sewer

OWNER CERTIFICATION

I, _____, certify that I am the owner and occupant of the property listed above and I certify that all the information contained in this application is true and correct to the best of my knowledge.

Owner Signature	Date
-----------------	------

CONTRACTOR CERTIFICATION

I, _____ of _____
certify that all work described above has been completed and has been performed in accordance with all applicable Village Code.

Contractor Signature	Date
----------------------	------

Submit completed application to: Village of Oak Park or E-mail to: housing@oak-park.us
Housing Programs Division
123 Madison St.
Oak Park, IL 60302



Sewer Backup Protection Grant Downspout Disconnection Waiver

The Village of Oak Park
Housing Programs Division
123 Madison St.
Oak Park, IL 60302

708.358.5410
708.358.5114 fax
housing@oak-park.us
www.oak-park.us

GENERAL INFORMATION

Owner Name Application Date

Building Address

Daytime Phone Number E-mail Address

DOWNSPOUT LOCATION(S)

Please identify individually all locations where you believe that disconnecting downspouts from the Village's combined sewer system and directing rain water on to your property would negatively impact neighboring property or create a hazardous condition.

Downspout Location Reason for Request

Downspout Location Reason for Request

Downspout Location Reason for Request

Downspout Location Reason for Request

Downspout Location Reason for Request

I hereby grant permission for property inspectors from the Village of Oak Park to enter my property for the purpose of verifying conditions for downspout discharge.

Owner Signature Date

OFFICE USE ONLY

The above referenced property currently has one or more downspouts connected to the Village of Oak Park combined sewer system which cannot be disconnected from the Village sewer system to have the runoff re-directed on to the owner's property without directing the runoff onto a neighbor's property or on to a paved area where ice would pose a hazard to pedestrians.

The Village of Oak Park will waive the requirement to disconnect downspouts from the Village combined sewer system at the following locations:

Downspout Location Downspout Location

Downspout Location Downspout Location

Downspout Location

Property Maintenance Inspector Signature Date

VILLAGE OF OAK PARK
SEWER BACKUP PROTECTION GRANT PROGRAM
HOMEOWNER PARTICIPATION AGREEMENT
(Submit in Duplicate)

THIS AGREEMENT made on this _____ day of _____, 202__ between the VILLAGE OF OAK PARK, 123 Madison Street, Oak Park, Illinois (hereinafter referred to as “Village”) and _____ (name) and _____ (name) at _____ (address) in Oak Park, Illinois (hereinafter referred to collectively as “Homeowner(s)”).

WITNESSETH:

WHEREAS, the Village has adopted a Sewer Backup Protection Grant Program to assist residents in their efforts to protect their homes from sewer backup. This Program provides a grant to Homeowners for certain basic costs of upgrading their plumbing in order to minimize sewage backflow. A copy of the Program Guidelines is incorporated in to this Agreement as **Exhibit A**; and

WHEREAS, Homeowner is the owner and occupant of the residence indicated above which has been the subject of occasional sewer backup; and

WHEREAS, the Homeowner has applied to participate in this Program and the Village has determined Homeowner to be eligible to participate.

NOW, THEREFORE, in consideration of the above and the terms and conditions set forth below, the parties hereto agree as follows:

Section 1: The findings set forth above are expressly made a part of this Agreement as if fully set forth in this Section 1.

Section 2: Definitions. The following terms shall have the following meanings when used in this Agreement unless the context clearly indicates a contrary meaning.

“Contractor” shall mean an Illinois Licensed Plumbing Contractor who is registered to do work in the Village of Oak Park and who has obtained the necessary licenses and permits from the Village to do work under this Program.

“Permit” is a Village permit which the Homeowner must obtain before any improvements can be installed by a Contractor.

“Program” is the Village’s Sewer Backup Protection Grant Program, operated in accordance with the Program Guidelines adopted by the Board of Trustees of the Village of Oak Park.

“Proposal” shall mean a Contractor’s detailed bid for equipment, material and labor, with quantities itemized.

Section 3: Village Approval. The Homeowner will submit all documentation required under the Program to the Village prior to the installation of any plumbing facilities, including the specific plans, Proposal, and an application for the necessary permits. No work shall begin until the Village approves the plans, the Homeowner pays the permit fee and the Village issues a building permit. If any work is done without Village permits, Homeowner will not be entitled to reimbursement for that work.

Section 4: Installation. Homeowner agrees to install the approved plumbing facilities in accordance with the Program within 6 months of application approval. The time may be extended upon written request of the Homeowner and written permission by the Village if the work is delayed because of weather, unavailability of a Contractor or other factors beyond the Homeowner's control where Homeowner has exercised reasonable diligence to timely complete the installation of the facilities.

Section 5: Contract for Work. The Homeowner's contract for the work shall be based on a Proposal approved by the Village. That proposal shall be attached to this Agreement and made part hereof as **Exhibit B.**

The contract for the installation will be between the Contractor and the Homeowner. The Village shall not be a party to such contract and has no liability for breach of contract or damages as a result of work improperly performed. Homeowner agrees that by operating this Grant Program, the Village does not assume any duty to the Homeowner or the Contractor for the performance of the work, the quality of the work or the condition of private property. The Village's only responsibility will be to make payment when there has been strict compliance with the Program Guidelines and this Agreement.

Section 6: Permit Required. The installation of the plumbing and electric facilities will require a permit issued by the Village's Department of Building and Property Standards.

Section 7: Inspections. The Homeowner must notify the Building and Property Standards Department to inspect the plumbing and electric work as required by that Department.

Section 8: Reimbursement Items. The Village will reimburse the Homeowner for those items which are considered eligible costs at their actual cost. The maximum amount of reimbursement is \$3,500.00 per property.

Section 9: Payment of Reimbursement. The Village will make reimbursement of eligible items at approved amounts when all work is completed, inspected and approved by the Village. To receive a reimbursement, Homeowner must follow all requirements of this Agreement and submit a claim on the Request for Reimbursement Form. Eligible costs include the following:

- a. Cost of location, excavation and exposure of the building sewer, including the support of existing structures, for reconnection to a new overhead sewer to the existing sewer line.
- b. Cost of a new pump pit, ejector pump and associated electrical and plumbing works needed to lift the drainage from basement plumbing fixtures to an overhead sewer or existing soil stack.
- c. Cost of trenching and concrete floor replacement.

- d. Cost of installing a backflow prevention valve with a bypass (new sump and sump pump in an underground vault) and associated electrical and plumbing work.
- e. Cost of grass seeding or sod to restore disrupted landscape.
- f. Battery backup system.
- g. Applicable permit fees.

Section 10: Homeowner's Responsibility. The Village will not reimburse the Homeowner for any of the following costs:

- a. Correction of subsidence in the excavated area. Settling of excavated soils is common. The Homeowner will be responsible for any future filling and reseeding.
- b. Future maintenance of ejector pump, backflow valve, overhead sewer, associated electrical equipment and all other related equipment and improvements. Like all equipment, this equipment and related items may require checking, service or repair in the future. The Homeowner is responsible for this future maintenance.
- c. Removal and replacement of interior basement walls and finishes.
- d. Use of materials not meeting the requirements of the Village's Specifications or Codes.
- e. Ancillary homeowner improvements not necessary to provide backup protection of the basement.
- f. Planting of new or replacement landscaping (bushes and trees) other than grass seeding or sod.
- g. New electrical panels and/or upgrading the house electrical supply.

Section 11: Liability Waiver. The Village of Oak Park, its officers and employees, are statutorily immune from liability for failing to inspect the condition of property that it does not own. In addition, the Village of Oak Park, by simply providing the funding for these improvements, is not undertaking to oversee the quality or the performance of the work. Inspections done by the Village under this program shall be the same as inspections the Village performs on any other permitted work in the Village. As such, the Village shall have no liability for the performance or non-performance of the work, or the quality of the work performed by contractors, or the condition of private property. The Village is not a party to the agreement between the Homeowner and its selected contractor and therefore will not be liable for breach of contract or damages caused by the contractor. The Village is not assuming any fiduciary or other duty to the Homeowner under this program. The Homeowner, by signing this agreement agrees, accepts and understands this and therefore, agrees to waive any claims against the Village of Oak Park, its employees, officers and agents ("the Village") and to indemnify, defend and hold the Village harmless against any and all claims whether in tort, contract or under any other theory of liability for any property damage, personal injury, economic, contractual damages or other damages or loss of any other kind which the Homeowner may acquire as a result of participating in this Program.

Section 12: Disclaimer. The Program is designed to assist homeowners in reducing the risk of basement flooding due to sewer backups. However, there is always a risk of a sewer backup as a result of unexpected sewer collapse, obstruction, power failure, extreme environmental or weather conditions or other unforeseen factors. Homeowner agrees to assume the risk of loss of any future property damage even after installation of these funded improvements.

In addition to overhead sewers, Homeowners should make sure their foundation drains are operated properly to prevent seepage of ground water through walls below grade. Existing foundation drains will not be tested for proper operation in the Program – the Homeowner has the responsibility for all testing, inspections and any corrective work that may become necessary.

Further, in order for overhead sewers, backflow prevention valves and foundation drains to function properly, the sump/ejector pump(s) must be reliable and function continuously. The Homeowner has the responsibility to check the operation of those pumps regularly. The Homeowner has the responsibility for all testing, inspections and any corrective work that may become necessary.

Homeowners should also install a battery backup system to provide protection in the event of power failure.

Section 13 Disconnection of Downspouts. As a requirement of this Program, Homeowner must disconnect any downspouts from the Village’s combined sewer system and must take all corrective action necessary to prevent the discharge of roof drainage into the Village’s combined sewer systems, unless an exemption is obtained from the Director of the Building and Property Standards Department.

Section 14: Breach. If the Homeowner fails to comply with all requirements of this Agreement or to complete installation as provided in this Agreement, the Village shall have no obligation to reimburse the Homeowner for eligible expenses.

VILLAGE OF OAK PARK

By: _____

Kevin J. Jackson, Village Manager

HOMEOWNER(S)

